

RIPTIDE 40/SC/T - 30" PARTS DIAGRAM

12 VOLT 42 AMPS

for use with "O" serial numbers
2-year warranty

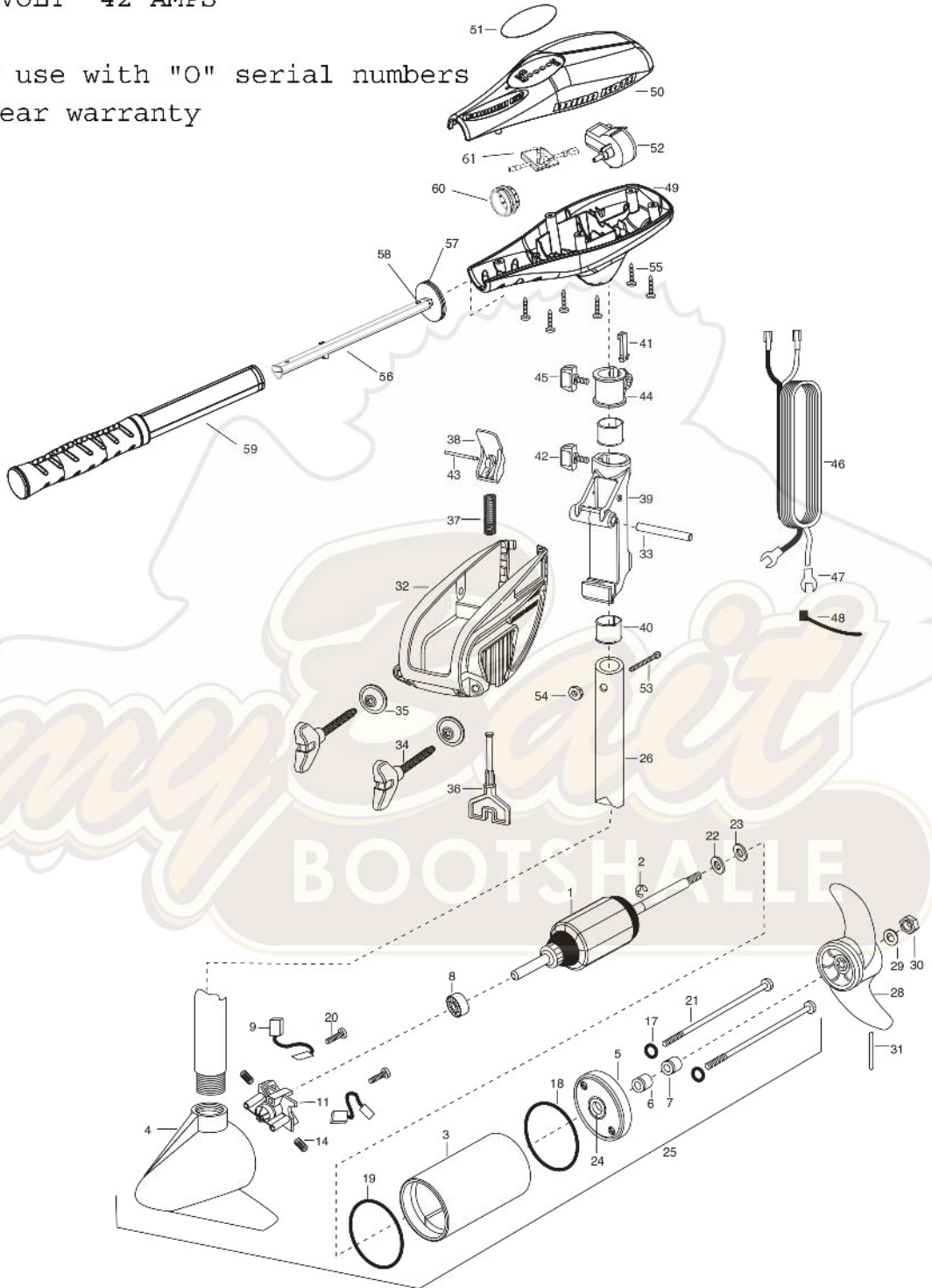

RIPTIDE 40/SC/T - 30" PARTS LIST

In the U.S.A., replacement parts may be ordered directly from MINN KOTA Parts Dept., 121 Power Dr., Mankato, MN 56002-8129. In Canada, parts may be ordered from any of the Canadian Authorized Service Centers. Visit minnkotamotors.com for a current listing. Be sure to provide the MODEL and SERIAL number of your motor when ordering parts. Please use the correct part numbers from the parts list. Payment for any parts ordered from the MINN KOTA parts department may be by Discover Card, Master Card or VISA. To order call 1-800-227-6433 or FAX 1-800-527-4464.

<u>Item</u>	<u>Part Number</u>	<u>Description</u>
1	2-100-202	ARMATURE ASSEMBLY 12v 3.25
2	788-015	RETAINING RING
3	2-200-379	HOUSING ASSEMBLY CENTER 3.25 SW TXT
4	2-300-332	BRUSH END HOUSING ASSEMBLY 3.25 5-SPC SW
5	2-400-328	PLAIN END HOUSING ASSEMBLY 3.25 SW
6	880-003	SEAL
7	880-006	SEAL W/SHIELD
8	140-010	BALL BEARING
9	188-052	BRUSH ASSEMBLY [2.EA]
11	738-030	BRUSH PLATE W/HOLDER 3.25
14	975-032	SPRING-COMPRESSION [2.EA]
17	701-007	O-RING- THRU BOLT [2.EA]
18	701-039	O-RING MK406460
19	701-041	O-RING
20	830-001	SCREW- SELF THREAD 8-32X1.7 [2.EA]
21	830-078	THRU BOLT 8-32X8.0 [2.EA]
22	990-067	WASHER- STEEL THRUST
23	990-070	WASHER- NYLATRON [2.EA]
24	144-049	FLANGE BEARING (SERVICE ONLY)
25	2069231	MOTOR ASSEMBLY 12 V 3.25 5SPC SW TXT
26	2002020	TUBE-COMPOSITE, WHT, 30"
■	1378121	PROP W/DRIVE PIN, WASHER, NUT KIT
28	2061122	PROPELLER 3.25 HUB DIA
29	2151726	WASHER- 5/16 STD SS
30	2198400	ANODE, ZINC, 3.25/3.62"
31	2092600	PIN-DRIVE
■	2771816	BRACKET & HINGE ASSEMBLY (INCLUDES 32-43)
■	2771913	BRACKET ASSEMBLY (INCLUDES 32, 34, 35)
*32	2061910	BRACKET
33	2060511	PIN-HINGE SS
*34	2061301	SCREW-CLAMP SS [2.EA]
*35	2331700	WASHER-CLAMP SCREW SS [2.EA]
36	2063605	T-BAR, PLASTIC
37	2062706	SPRING- (T-BAR)

PARTS LIST (cont.)

<u>Item</u>	<u>Part Number</u>	<u>Description</u>
38	2067201	LEVER-TILT BLACK
39	2061810	HINGE-PLASTIC
40	2037301	BUSHING-HINGE [2.EA]
41	2062800	TENSION BLOCK-SNAP IN
42	2011386	SCREW, TENSION/KNOB SS
43	2060516	PIN, TILT LEVER SS
44	2061520	COLLAR-DEPTH
45	2011366	SCREW-COLLAR/NEW KNOB SS
46	2020631	LEADWIRE (10 GA) FLAG/PIGGYBACK
47	2020703	SPADE TERMINAL 14GA HD [2.EA]
48	2026300	TIE WRAP
49	2062517	CONTROL BOX WHT
50	2060218	CONTROL BOX COVER WHT
51	2095631	DECAL COVER RIPTIDE BATTERY METER
52	2064028	SWITCH-FWD/REV 5 SP
53	2033403	SCREW-10-24 X 1-3/4 SS
54	2333101	NUT-10-24 HEX SS
55	2372100	SCREW-8-18 X 5/8 SS [6.EA]
56	2990919	INNER HANDLE ASSEMBLY
57	2060405	PIVOT, HANDLE
58	2012104	SCREW-6 x 1/2" SS
59	2990928	OUTER HANDLE ASSEMBLY
60	2060009	FRONT BEARING
61	2074080	BATTERY METER 12V, SW
■	2883460	SEAL AND O RING KIT

* This item is part of an assembly. This item cannot be sold separately due to machining and/or assembly that is required.

WIRING DIAGRAM

